

uitwerkbijlage

Naam kandidaat _____ Kandidaatnummer _____

2

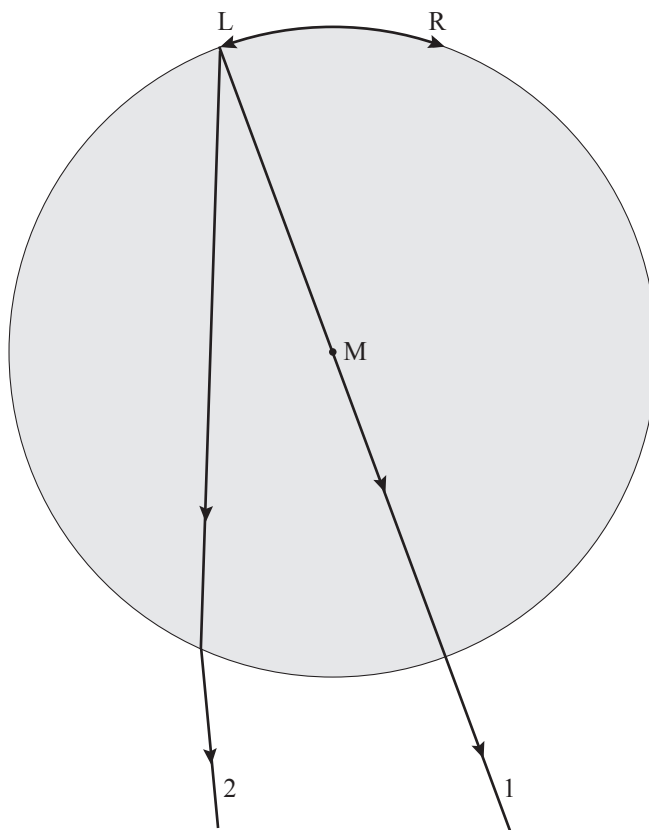

ruimte voor de bepaling van de brekingsindex:

.....
.....
.....
.....

3

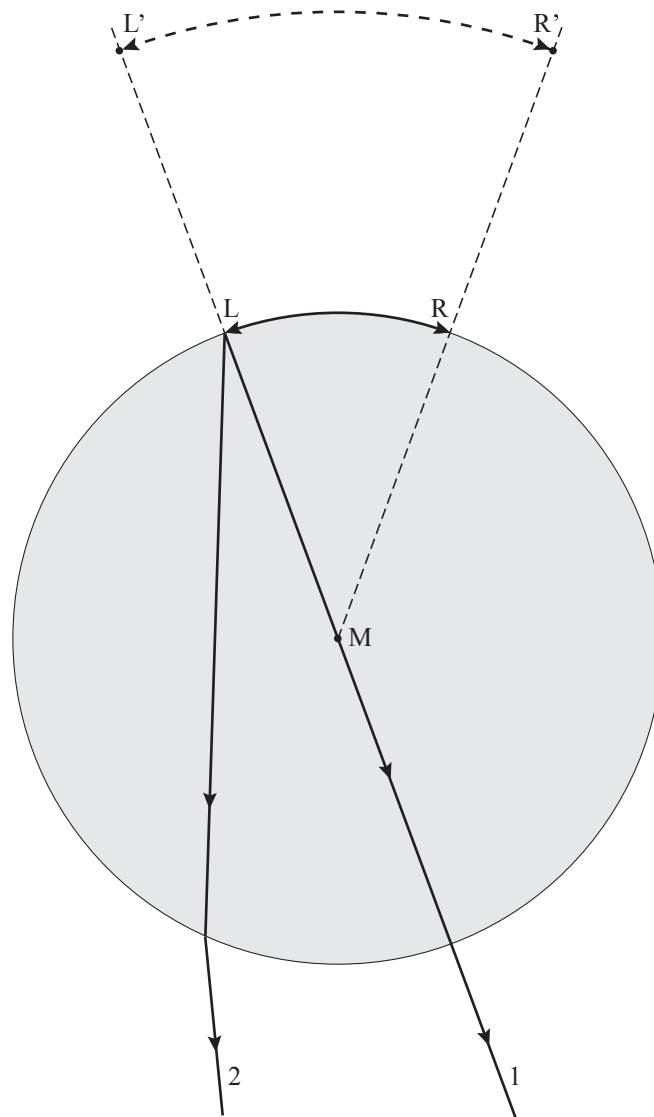

ruimte voor uitleg:

.....

.....

.....

4 ruimte voor de bepaling van N :

.....

.....

.....

.....

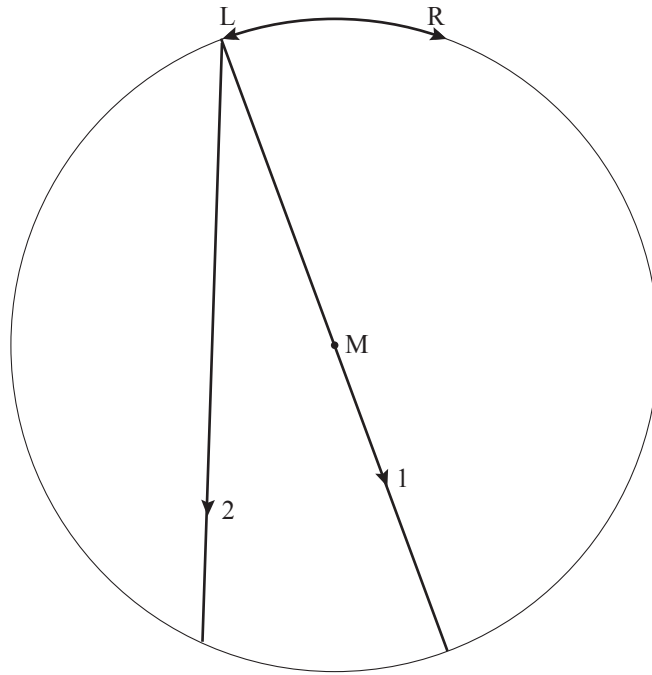

ruimte voor een toelichting:

.....

.....

.....

.....

9

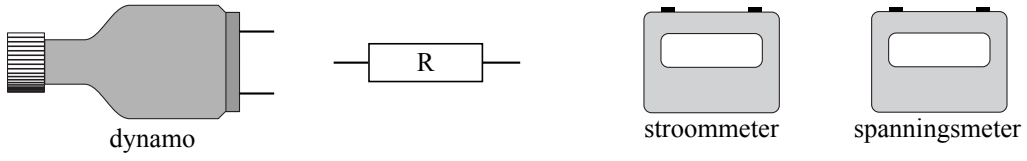

15

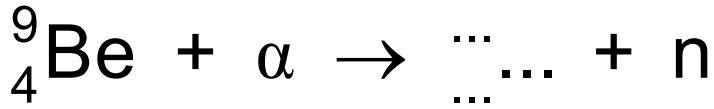

19

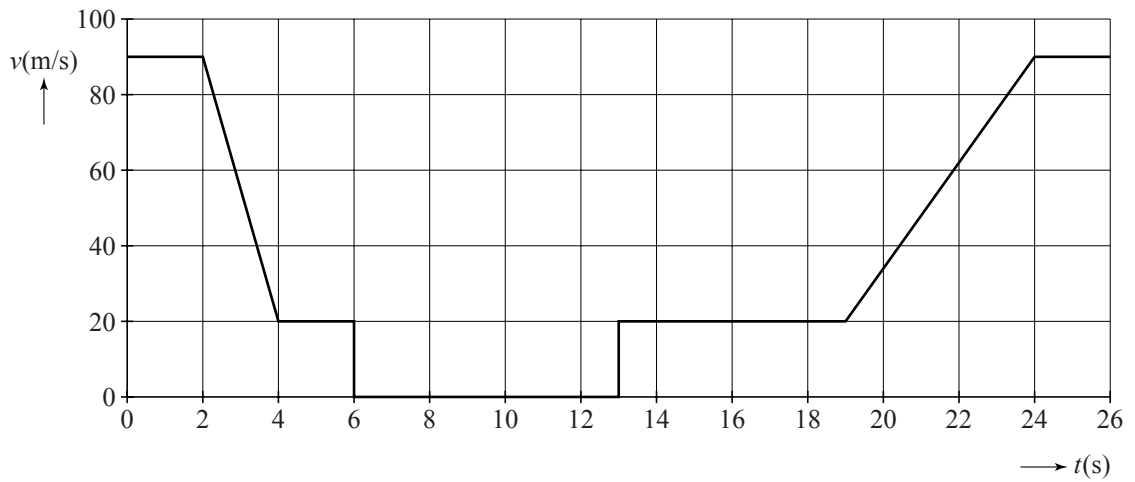

ruimte voor een berekening:

.....

.....

.....

.....

.....

22

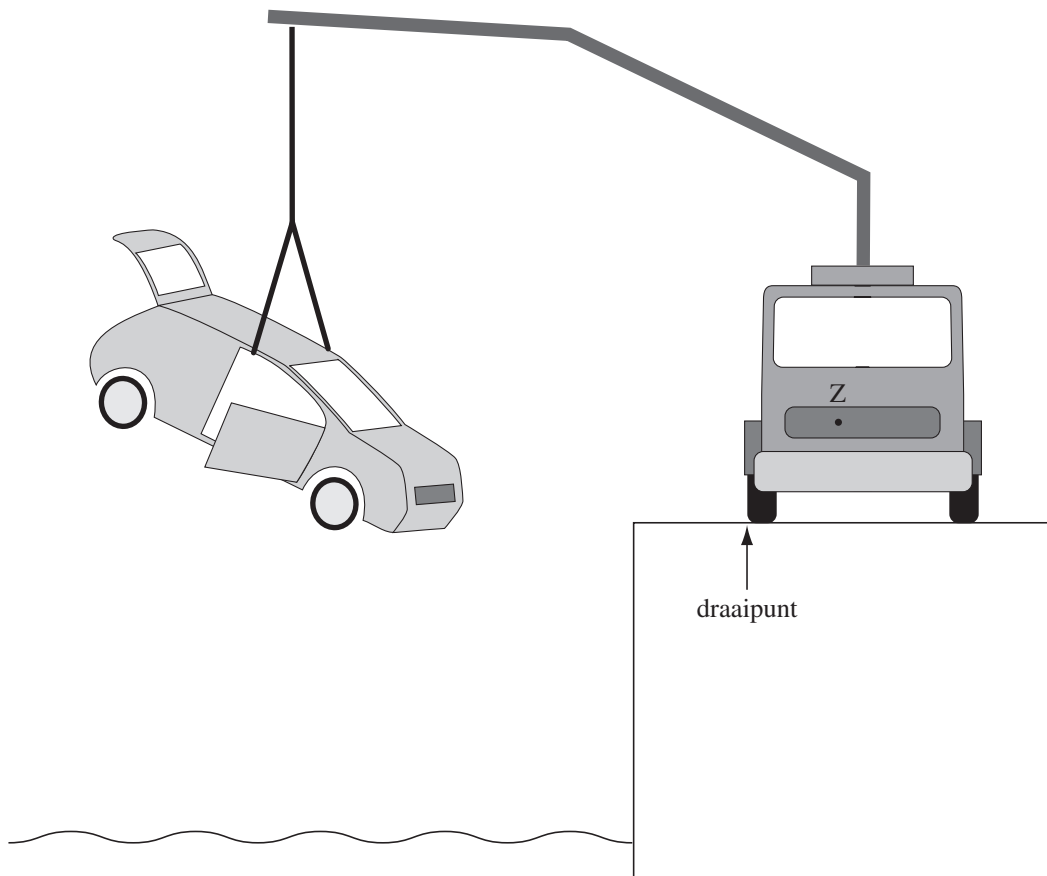

23



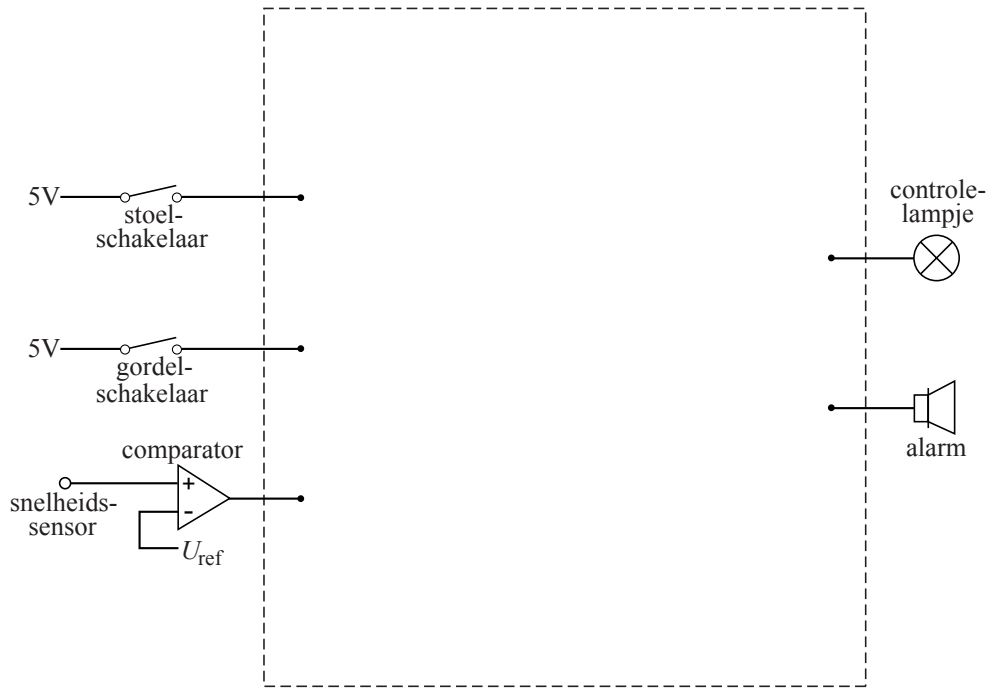

$U_{ref} = \dots\dots\dots$

VERGEET NIET DEZE UITWERKBIJLAGE IN TE LEVEREN