

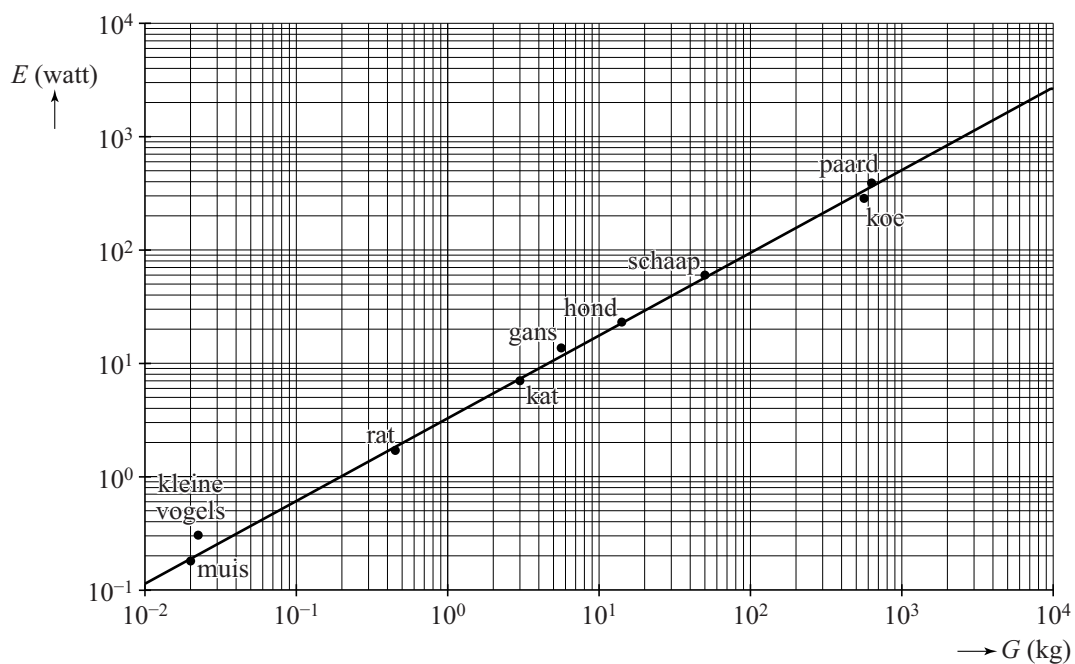

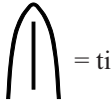







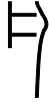
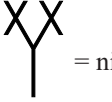

uitwerkbijlage









Naam kandidaat _____ Kandidaatnummer _____

3



	klinker 1	klinker 2
medeklinker 1	 = ti	
medeklinker 2		
medeklinker 3	 = ni	
medeklinker 4		
medeklinker 5		





A - mi - ni - so

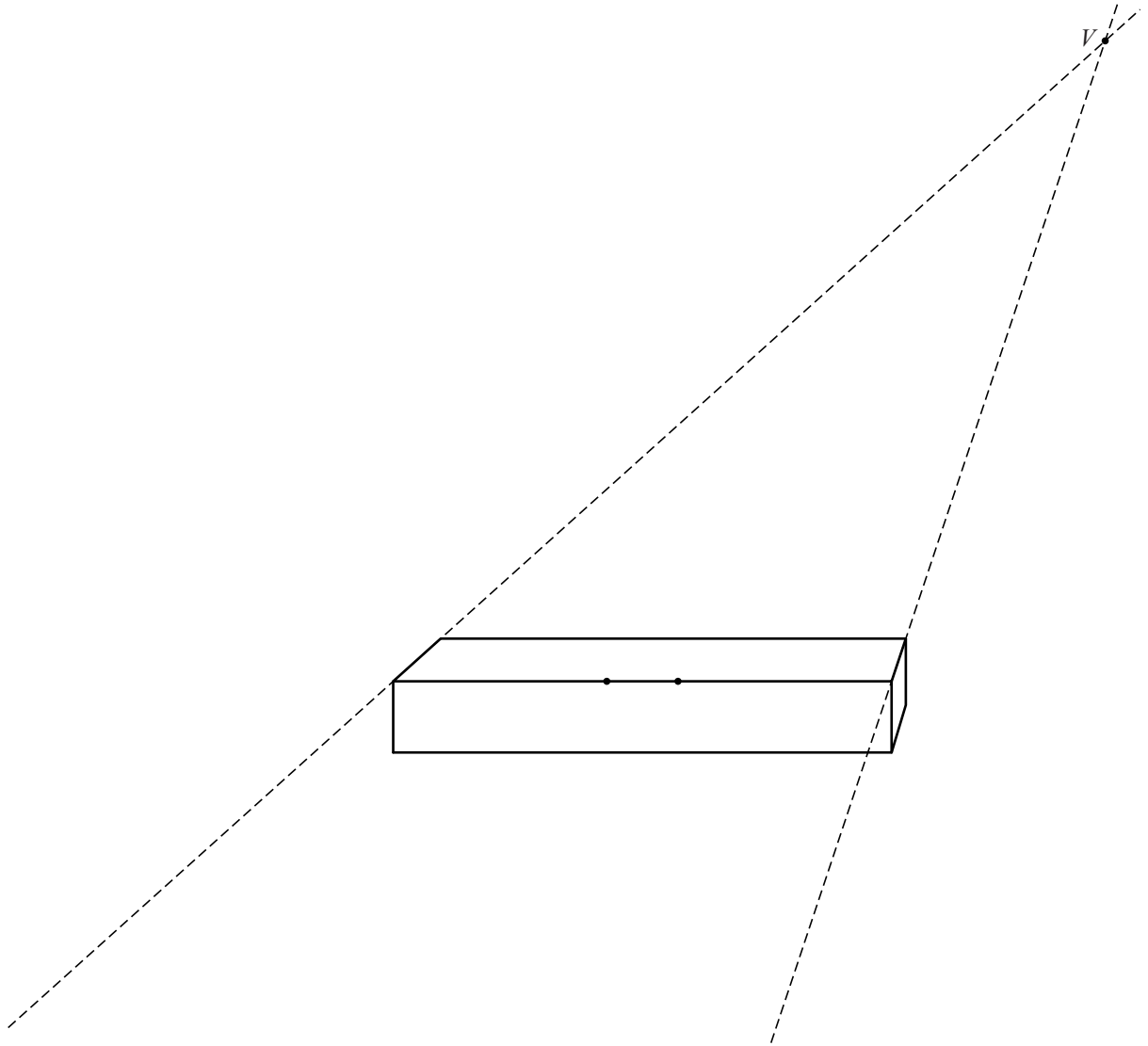







 woord 1 woord 2 woord 3





VERGEET NIET DEZE UITWERKBIJLAGE IN TE LEVEREN